

гостиная НЕНСИ 1 / NANCY 1

Код ТН ВЭД ЕАЭС

9403 60 100 1
9403 90 300 0



отрезать
и приклеить

| | | |
|------|------|-----|
| | | |
| 2800 | 2000 | 466 |

Левое исполнение/
Left

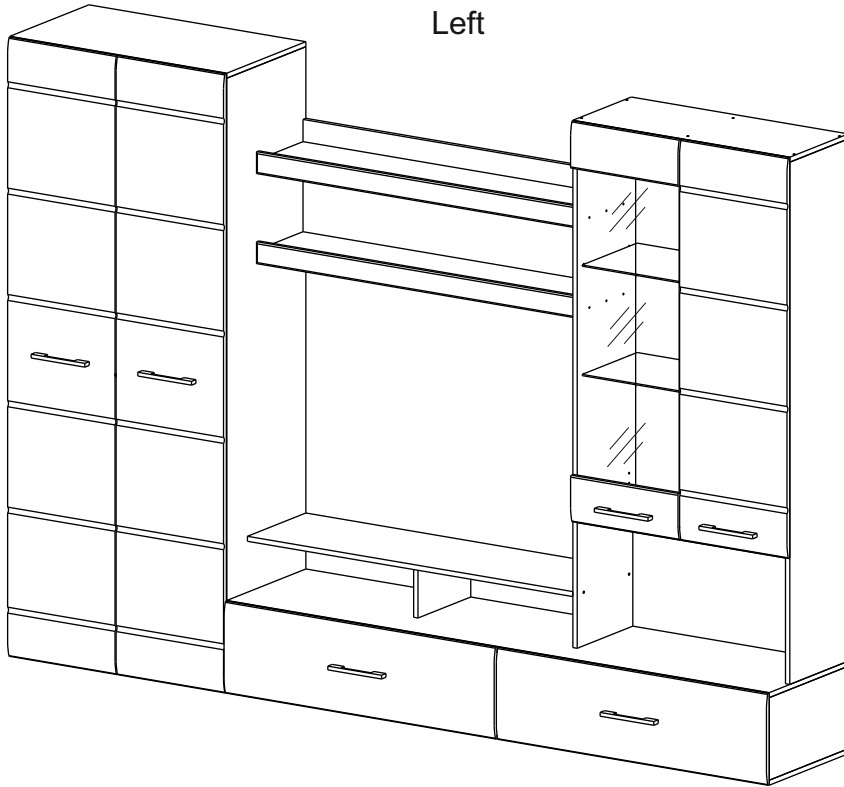

корпус [39НВГ12547
39НЯГ12570
39НДГ12559

фасад [39ФБГ12581
39ФКГ12592

Правое исполнение/
Right

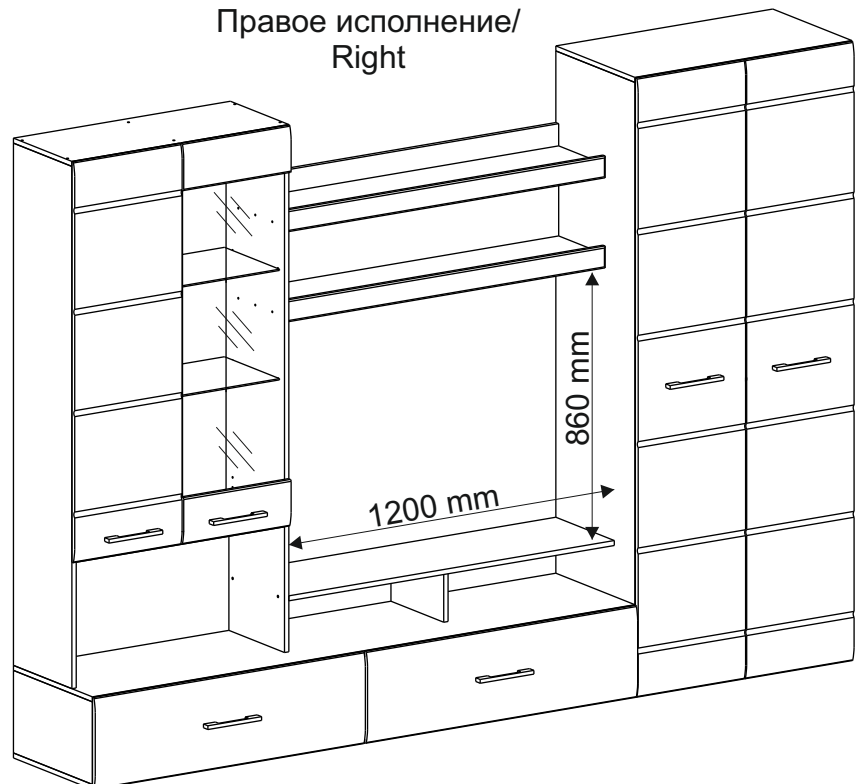

(PL) Instrukcja montażu

(CZ) Návod k montáži

(D) Montageanleitung

(GB) Assembly instruction

(F) Model d'emploi

(HU) Szerelési útmutató

(I) Istruzione di montaggio

(NL) Handleiding voor de montage



(RU) Инструкция по монтажу

(RO) Instrucțiuni de montare

(SK) Návod k montáži

(TR) Montaj talimatı

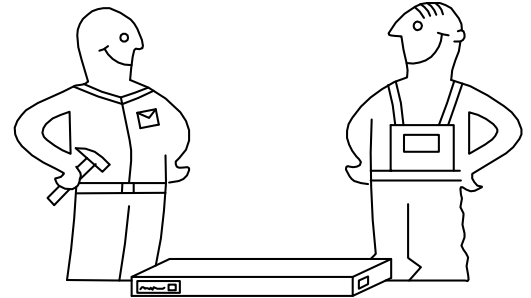
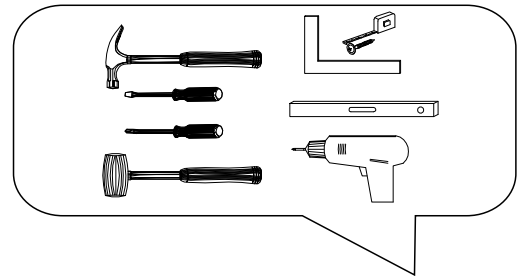

| ⚠ Uwaga • Upozornění • Achtung • Attention • Caution • Figyelem Attenzione • Opgelet • Внимание • Atenție • Upozornenie • Dikkat ⚠ | |
|--|--|
| PL | Czyszczenie należy wykonać wyłącznie za pomocą ściereczki lub lekko nawilżonego ręcznika. Nie stosować środków czyszczących do szorowania. |
| CZ | Čistění je nutné vykonávat výhradně pomocí utěrky nebo lehce navlhčeného ručníku. Nepoužívejte čističe obsahující abrazivní částice. |
| D | Bitte nur mit einem Staubtuch oder leicht feuchtem Lappen reinigen. Keine scheuernden Putzmittel verwenden. |
| GB | Please only clean with a duster or a damp cloth. Do not use any abrasive cleaners. |
| F | Le nettoyage se fait uniquement à l'aide d'un torchon ou d'une serviette légèrement mouillée. |
| HU | A tisztítás kizárólag törülköh vagy enyhén nedvesített törölköző segítségével végezhető. Súroló hatású tisztítószerket nem szabad használni. |
| I | Pulire esclusivamente con un panno o un asciugamano umido. |
| NL | Reinig alleen met een stofdoek of een lichtjes vochtige doek. Gebruik geen schurende poetsmiddelen. |
| RU | Очищайте от пыли тряпкой или слегка влажной ветошью. Не допускается применение чистящих средств, не предназначенных для ухода за мебелью. |
| RO | Curățarea trebuie efectuată numai cu o cârpă sau cu un prosop ușor umezit. Nu utilizați agenți de curățare abrazivi. |
| SK | Čistení je nutné vykonávat výhradne pomocí utierky alebo ľahko zvlhnutým ručníkom. Nepoužívajte čistiace prostriedky obsahujúce abrazívne častice. |
| TR | Lütfen sadece bir toz bezilye veya hafif nemli yumuşak bir bezle siliniz. Aşındırıcı temizlik malzemeleri kullanmayınız. |

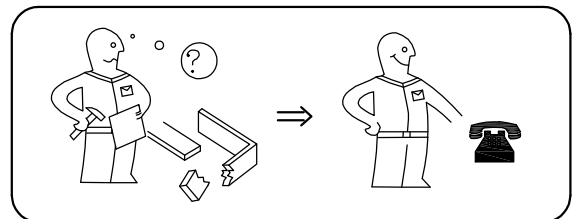
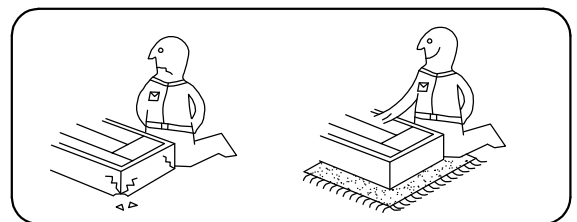

Karta serwisowa • Servisní list • Service Karte • Service card • Carte de service • Szervizkártya
Scheda di servizio • Service kaart • Сервисная карта • Fisa service • Servisný list • Servis karti

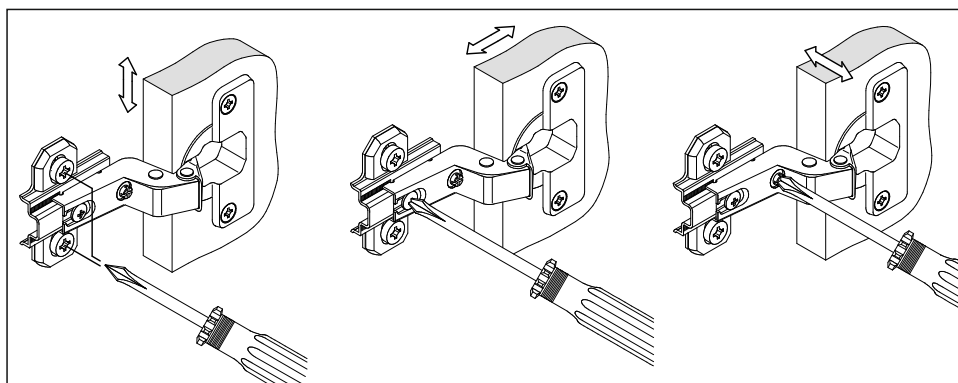
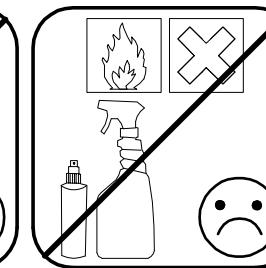
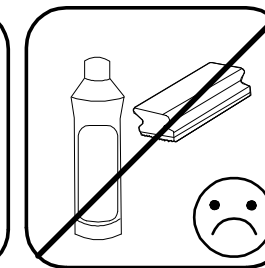
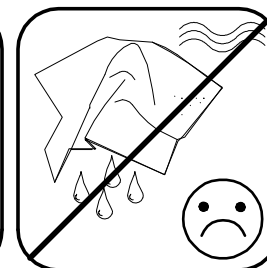
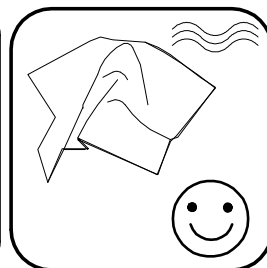
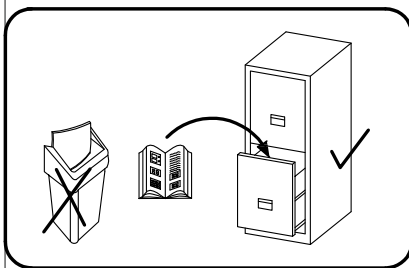









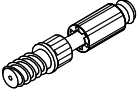

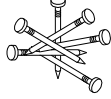

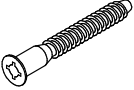
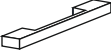

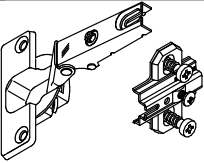
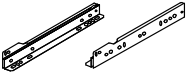

Комплектовочная ведомость / Set package sheet

| Упак/ Pack | Наименование | Description | Décor | | | Размер/ Size, mm | Кол-во/ Quantity | № | | | |
|---------------|-----------------|------------------------------|-------|-----------|----------|---------------------|---------------------|----|---------|---|----|
| | | | Wenge | Ash light | Oak gold | | | | | | |
| 1 | Фурнитура | Furniture/Cabinetry hardware | | | | - | 1 | | | | |
| 2 | Боковина | Side | Wenge | Ash light | Oak gold | 163x298 | 1 | 1 | | | |
| | Боковина средн | Side middle | | | | 1252x330 | 1 | 3 | | | |
| | Боковина правая | Side right | | | | 1670x330 | 1 | 4 | | | |
| | Боковина левая | Side left | | | | 1670x330 | 1 | 5 | | | |
| | Боковина левая | Side left | | | | 1950x446 | 1 | 6 | | | |
| | Боковина правая | Side right | | | | 1950x446 | 1 | 7 | | | |
| | Вязка | Connecting element | | | | 1200x330 | 1 | 14 | | | |
| | Вязка | Connecting element | | | | 376x330 | 2 | 15 | | | |
| | Детали ящика | Side drawers | | | | 134x908 | 4 | 21 | | | |
| 3 | Боковина левая | Side left | Wenge | Ash light | Oak gold | 264x446 | 2 | 2 | | | |
| | Боковина правая | Side right | | | | 264x446 | 2 | 38 | | | |
| | Крышка верх | Top high | | | | 2000x446 | 1 | 8 | | | |
| | Крышка низ | Top low | | | | 2000x446 | 1 | 9 | | | |
| | Вязка | Connecting element | | | | 1200x250 | 2 | 13 | | | |
| | Задник | Back element | | | | 1200x446 | 1 | 17 | | | |
| | Детали ящика | Side drawers | | | | 134x400 | 4 | 20 | | | |
| | ДВП | Back element | | | | 1996x286 | 1 | 31 | | | |
| | Соед. Элемент | Connecting Back element | | | | - | - | - | 1146 мм | 1 | 34 |
| | Штанга | Wardrobe tube | | | | - | - | - | 763 мм | 1 | 19 |
| 4 | Крышка шкаф | Top cabinet | Wenge | Ash light | Oak gold | 800x446 | 2 | 10 | | | |
| | Крышка пенал | Top | | | | 800x330 | 1 | 11 | | | |
| | Вязка пенал | Connecting element | | | | 768x330 | 1 | 12 | | | |
| | Вязка шкаф | Connecting element cabinet | | | | 768x446 | 2 | 16 | | | |
| 5 | ДВП | Back element | Wenge | Ash light | White | 400x940 | 2 | 28 | | | |
| | ДВП | Back element | | | | 410x796 | 1 | 29 | | | |
| | ДВП | Back element | | | | 399x796 | 1 | 30 | | | |
| | ДВП | Back element | | | | 416x796 | 1 | 18 | | | |
| | ДВП | Back element | | | | 1160x396 | 2 | 32 | | | |
| | ДВП | Back element | | | | 1276x396 | 2 | 33 | | | |

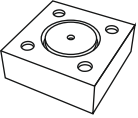
Продается отдельно/Sold separately

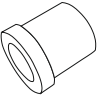
| Упак/ Pack | Наименование | Description | Décor | | Размер/ Size, mm | Кол-во/ Quantity | № |
|---------------|----------------|--------------------|------------------------|----------|---------------------|---------------------|----|
| | | | White gl | Cacao gl | | | |
| 1 | Створка левая | Door left | White gl | Cacao gl | 1980x396 | 1 | 22 |
| | Створка правая | Door right | | | 1980x396 | 1 | 23 |
| | Створка | Door | | | 1282x396 | 1 | 24 |
| | Фасад верхний | Door element high | | | 150x396 | 1 | 25 |
| | Фасад нижний | Door element low | | | 150x396 | 1 | 37 |
| | Панель левая | Drawer panel left | | | 294x996 | 1 | 26 |
| | Панель правая | Drawer panel right | | | 294x996 | 1 | 39 |
| | Планка | Plank | | | 1200x70 | 2 | 27 |
| 2 | Стеклополка | Glass shelves | прозрачное/transparent | | 365x310 | 2 | 35 |
| | Стекло | Glass | | | 1030x370 | 1 | 36 |

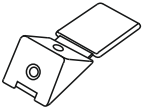
| | | | | | | | | | |
|---|------|---|---------------|---|--------|---|----------|---|--|
| 1 | | 2 | | 73 | | 48 | 2x20 | 49 | |
|  | |  | |  | |  | |  | |
| 26 x | | 26 x | | 16 x | | 100 x | | 2 x | |
| 5 | 7x50 | 117 | C 39 (160 mm) | 72 | | 6 | 6,3x10,5 | 45 | |
|  | |  | |  | |  | |  | |
| 66 x | | 6 x | | 40 x | | 34 x | | 20 x | |
| 91 | A | 24 | 400 mm | 18 | 3,5x15 | 15 | | 41 | |
|  | |  | |  | |  | |  | |
| 13 x | | 2 x | | 106 x | | 1 x | | 8 x | |
| 38 | | 70 | d5 | 21 | | 14 | 3,5x30 | 44 | |
|  | |  | |  | |  | |  | |
| 10 x | | 18 x | | 6 x | | 10 x | | 6 x | |

Decor (the handle):

Oak gold - C 42 (128 mm)

Wenge, Ash light - C 39 (160 mm)

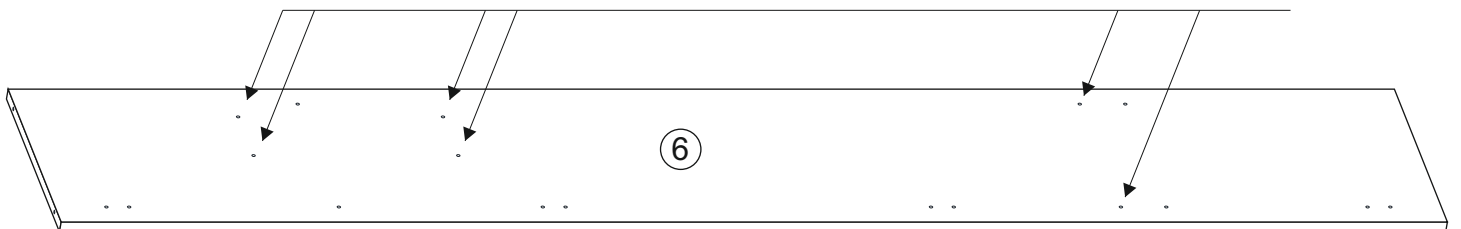
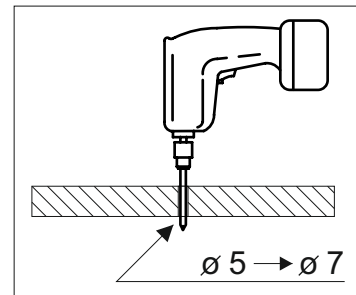
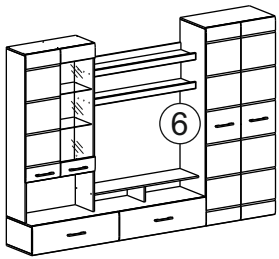
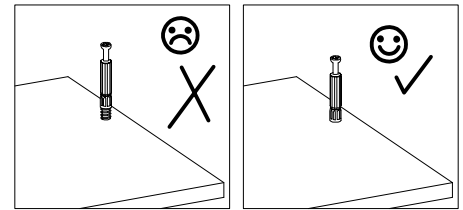
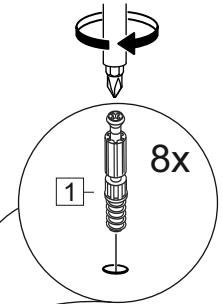
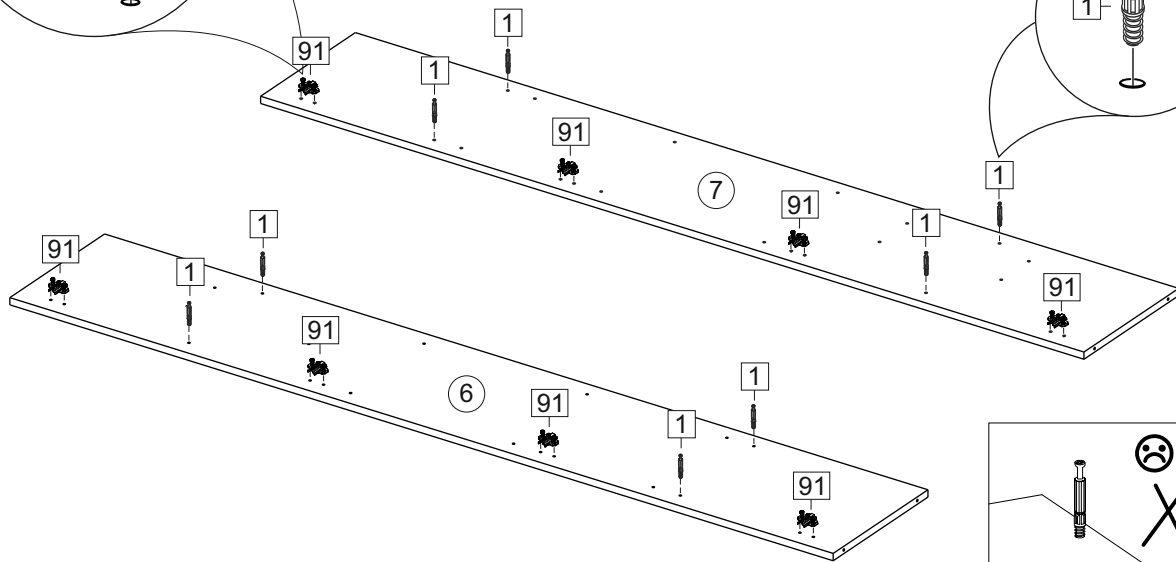
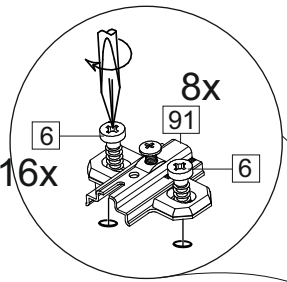
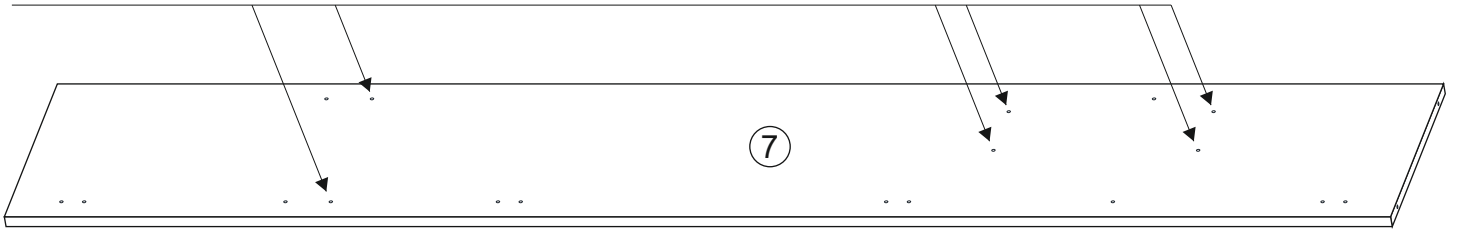
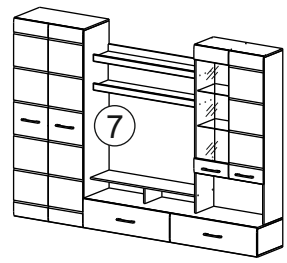
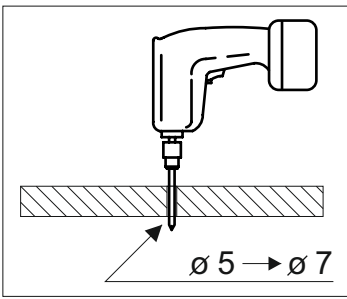

6

